

2024_04_12_huntly_rally

The Wild Geese

32J - 3C/4L - Unknown

Bars

- 1-8 1s+3s set advancing & Bal-in-Line (Man above Lady), turn partners RH & 1s cast to 3rd place **while** 3s lead up to 1st place
- 9-16 3s+1s set advancing & Bal-in-Line (Man above Lady), turn partners RH & 3s cast to 3rd place **while** 1s lead up to 1st place
- 17-24 1s lead down & back to 2nd place
- 25-32 2s+1s dance R&L

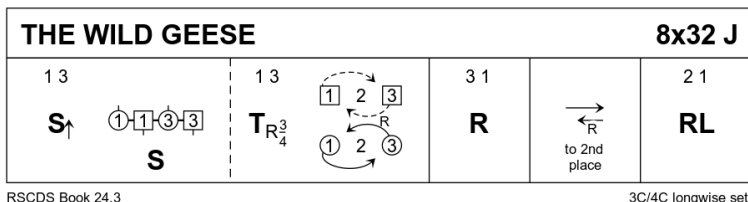

The Spring Fling Reel

40R - 3C/4L - Samantha Burton

Bars

- 1-8 1s turn RH, cast (2s step up bars 3-4), cross RH, cast to Right to 1L between 2s facing down, 1M between 3s facing up
- 9-16 1L+2s & 1M+3s Adv+Ret, circle 6H 1/2 round to Left
- 17-24 1M+3s & 1L+2s Adv+Ret, 1s turn RH 1.1/4 times to face 1st corners
- 25-32 1s dance 1/2 diag reel of 4 with 1st corners, pass RSh, 1/2 diag reel of 4 with 2nd corners. 1s end in middle 1M below 1L facing own sides
- 33-40 1L+2s & 1M+3s dance LH across. 1s end 2nd place opposite sides. 2s+3s turn LH **while** 1s turn RH 1.1/2 times to own side. 2 1 3

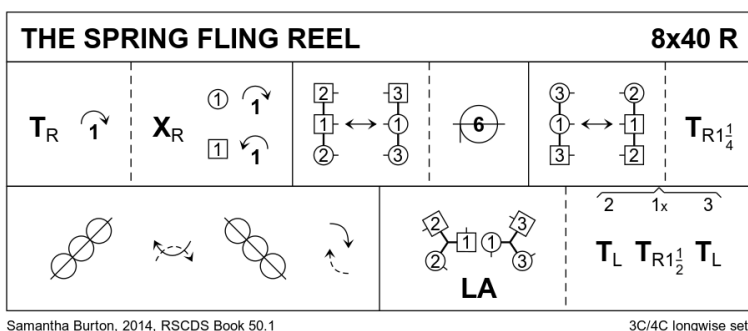

The Cashmere Shawl

32S - 3C/4L - Iain Boyd

Bars

- 1-8 1s turn RH & cast down 2 places, cross LH & cast up to 2nd place opposite sides
- 9-16 1s turn RH & turn 1st corners LH, turn 2nd corners RH & turn partner LH to face 1st corners
- 17-24 1s 1/2 diagonal reel of 4 with 1st corners, pass RSh & dance 1/2 diagonal reel with 2nd corners. (3)(1)(2)
1s (centre couple) change places RH with person diagonally to Right, New centre couple change LH with person diagonally to Left, New centre couple change RH with person diagonally to Right All cross LH
- 25-32

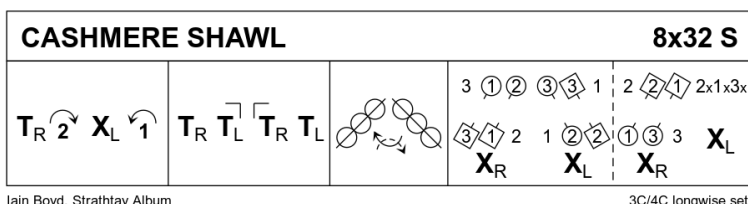

Napier's Index

40J - 3C/4L - Brian Charlton

Bars

- 1-8 1s set & cast 1 place, turn LH 1.1/4 times to end in Bal-in-Line position between 1st corners
- 9-16 1s+1st corners Bal-in-Line & turn corners RH (4 bars) to Bal-in-Line again with 1st corners
- 17-24 1s dance reel of 3 on sides (LSh to 2nd corner) & end diagonally between 2nd corners
- 25-32 1s+2nd corners Bal-in-Line & turn corners RH (4 bars), Bal-in-Line again with 2nd corners
- 33-40 1s dance reels of 3 across (LSh to 3rd corners) & cross RH to 2nd places

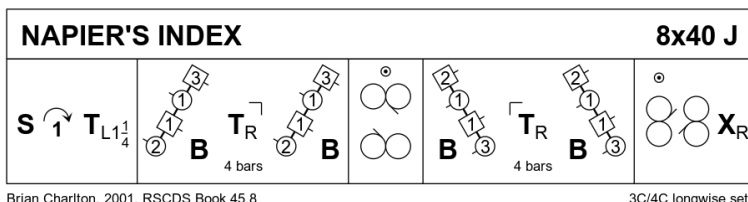

Peacocks in the Glen

32R - 4C/4L - Alison Austin

Bars

- 1-8 1s+4s set, cast down/up 1 place & dance 1/2 Fig 8 round end couples (2s & 3s step up/down bars 3-4)
- 9-16 1s+4s dance RH across & face corners; 1s+4s turn corners 1.1/2 LH (or birl) to change places
- 17-24 2s+3s dance RHA, turn corners 1.1/2 LH (or birl) to end 2 (1) (4) 3
- 25-32 1s+4s Set+Link; 1s dance 1/2 Fig 8 down round 3s **while** 4s dance 1/2 Fig 8 up round 2s. 2 4 1 3

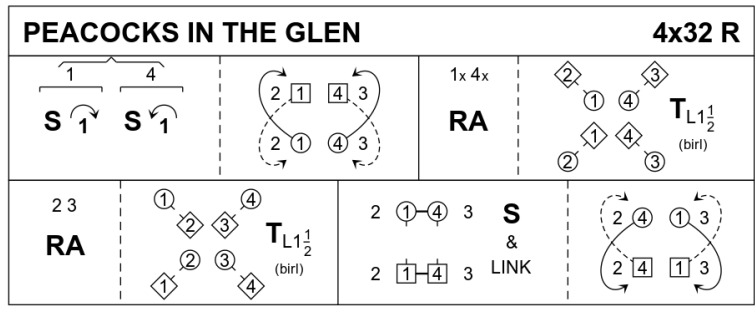

Alison Austin, 2015, RSCDS Dunfermline 90th Anniversary

4C/4C longwise set.

[Saint Columba's Strathspey](#)

32S - 5C/5L - Vicky Sproule & Sadie L. Gillan

Bars

- 1-8 2s+4s dance RH across, 2s dance up **while** 4s dance down, 2s & 4s casting round ends on own sides to face 1st corners
- 9-16 2s+4s Pass+Turn with 1st corners, pass partner LSh & Pass+Turn with 2nd corners & into centre facing partner (L facing down M up)
- 17-24 2s+4s dance reel of 4 ending in original places on sides
- 25-32 2s & 4s set & cast down 1 place **while** 3s & 5s set & dance up 1 place, 1s & 2s turn RH & cast down 1 place. 3 1 5 2 4

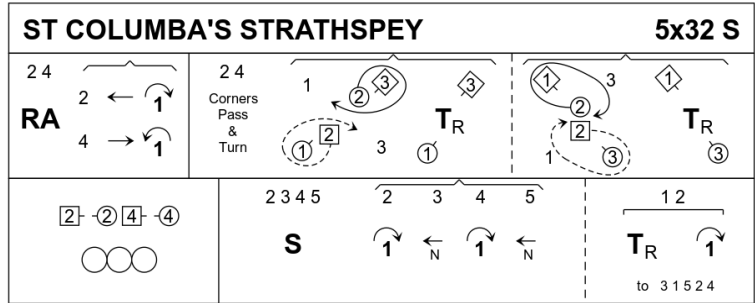

Sadie Gillan and Vicky Sproule, 1985

5C/5C longwise set.

[The Luckenbooth Brooch](#)

32J - 3C/4L - John Bowie Dickson

Bars

- 1-8 1s in prom hold (Lady on Man's left) dance reel of 3 with 2s (RSh to 2M) & end facing 3M
- 9-16 1s dance reel with 3s (RSh to 3M) ending with 1s dancing into centre facing Men's side
- 17-24 1M casts up & 1L dn into centre & dance out Ladies' side, 1M cast up & 1L dn to end 1M b'tw'n 2s facing dn & 1L+3s face up as 2s+3s dance R&L
- 25-32 2s+1s+3s set twice, 1s turn RH 1.3/4 times to 2nd places

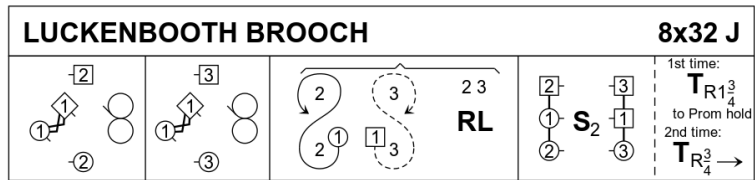

John Bowie Dickson, Glendarroch Sheet 28

3C/4C longwise set.

[The Rutland Reel](#)

40R - 3C/4L - Robert Senior

Bars

- 1-8 1s set & cast 1 place (2s step up); 1s cross down between 3s & cast up to 2nd place opposite sides
- 9-16 1s+2s dance Ladies' Chain & end 1s facing down
- 17-24 Reels of 3 on sides, 1s giving RSh to 3s (6 bars) & 1s+3s change places RH 2 3(1)
- 25-32 3s+1s dance Men's Chain & end 1L facing out with partner ready to follow her
- 33-40 1L followed by partner casts up & crosses to own side to end with 1s in 2nd place own sides; 1s+3s circle 4H round to left

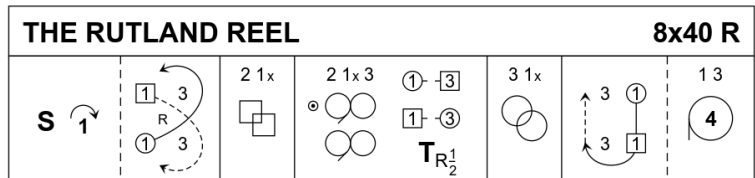

Robert Senior, 2010, The Sunday Class 1, RSCDS Book 48.2

3C/4C longwise set.

[The Moray Rant](#)

48S - 3C/3L - John Drewry

Bars

- 1-8 1s dance Inveran Reels with 2s+3s & 1s cross RH to opposite sides
- 9-16 1s set advancing & turn 2H, dance down & out between 2s & 3s then cast down behind 3s to turn in to face 3s
- 17-24 1s set & turn 3s (1s dancing out between 2s & 3s), dance up between 3s & out between 2s+3s then cast up behind 2s to turn in to face 2s
- 25-32 1s set & turn 2s (1s dancing out between 2s & 3s) into 1st place opp sides, 1s dance 1/2 Fig of 8 round 2s back to 1st place own sides
- 33-40 1s+2s circle 4H once round to Left, 1s facing 2s set & 1s cast to 2nd place as 2s lead up to 1st place
- 41-48 1s+3s circle 4H once round to Left, 1s facing 3s set & 1s cast to 3rd place as 3s lead up to 2nd place

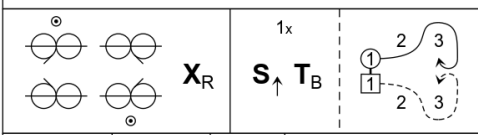
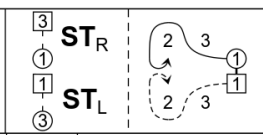
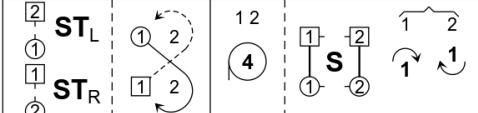
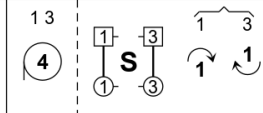
THE MORAY RANT				3x48 S
				
				

John Drewry, 1968, Silver City

3C/3C longwise set.

[The Diamond Jubilee](#)

32J - 4C/4L - Robert M Campbell

Bars

- 1-8 1s & 4s turn 1.1/2 times RH & cast 1 place, 1M & 4M also 1L & 4L turn LH on sides to end 1s facing up & 4s down. 2(1)(4)3
All dance reels of 4 on sides (Bar 16 1s & 4s do not pass LSh but turn right about into centre BtoB facing corner just passed). 2(4)(1)3
- 9-16 4s & 1s set to corners & change places RH, set & change back LH
- 17-24 4s & 1s set to corners & change places RH, set & change back LH
- 25-32 4s+1s dance RH across **while** 2s & 3s set & cross RH, all set & cross RH back to places 2 4 1 3

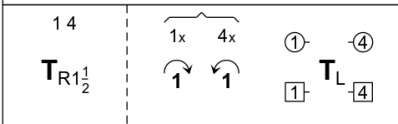
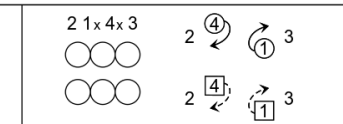
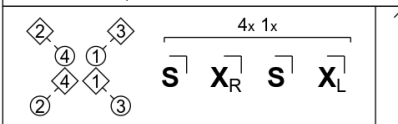
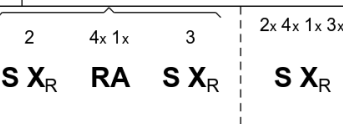
THE DIAMOND JUBILEE				4x32 J
				
				

Robert M Campbell, 1981, RSCDS Book 31.1

4C/4C longwise set.

[Granville Market](#)

32J - 3C/4L - Elinor M Vandegrift

Bars

- 1-8 1s+2s dance RH across & LH back
- 9-16 1s cross RH & cast 1 place, 1s dance 1/2 Fig of 8 around 2s & end facing 1st corner
- 17-24 1s turn corners RH & pass RSh to face 2nd corners, 1s turn 2nd corners RH & pass RSh to end 2nd place own sides
- 25-32 2s+1s+3s circle 6H round & back

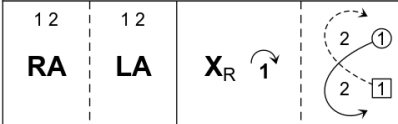
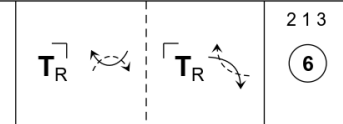
GRANVILLE MARKET				8x32 J
				

Elinor M Vandegrift, RSCDS Graded Book 2.18

3C/4C longwise set.

[Duke of Perth](#)

32R - 3C/4L - Unknown

Bars

- 1-8 1s turn RH, cast to 2nd place, turn LH to face 1st corners
- 9-16 1s turn 1st corner, partner, 2nd corner, & partner to face 1st corners
- 17-24 1s set to & turn 1st corner 2H, set to & turn 2nd corner
- 25-32 1s dance Reel of 3 on opposite sides giving LSh to 1st corner & cross back to own sides

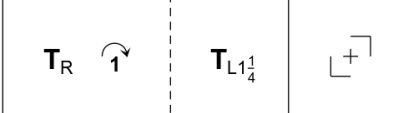
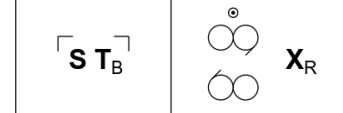
DUKE OF PERTH		Pease Strae or Broun's Reel		8x32 R
				

Boulogne, 1827, RSCDS Book 1.8

3C/4C longwise set.

[The Garry Strathspey](#)

32S - 4C/4L - James B Cosh

Bars

- 1-8 1s+2s & 3s+4s dance 1/2 R&L, 1s+4s (middle couples) dance 1/2 R&L
2s+4s & 1s+3s circle 4H left 1/2 way, 2s+3s (middle couples) circle 4H right 1/2 way; 1s dance up to top (2s+3s+4s step down) & all face as for Reel of 4 on sides
- 9-16 All set HS & dance 1/2 Grand Chain. All end on own side 2 3 4 1

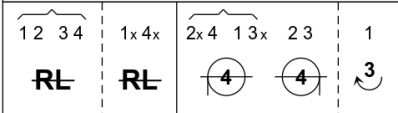
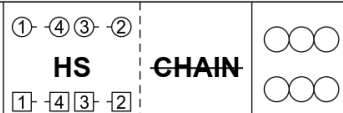
THE GARRY STRATHSPEY				4x32 S
				

James Cosh, 22 SCD & One Other

4C/4C longwise set.

25- All dance Reel of 4 on sides. 2 3 4 1
32

Inchmickery
32J - 5C/5L - Roy Goldring

- Bars**
- 1-8 1s+2s circle 4H round to left, 1s dance in & cast to 3rd place
- 9-16 1s dance RH across (1L with 3s & 1M with 4s), pass RSh & dance LH across with other couple 2 3 1 4 5
- 17- 1L+2M (at top) also 1M+5L (at bottom) turn RH, 1s pass RSh &
24 1L+5M (at bottom) also 1M+2L (at top) turn LH (1s end 3rd place own side)
- 25- 1s dance in & cast to 5th place, 5s+1s circle 4H round to right.
32 2 3 4 5 1

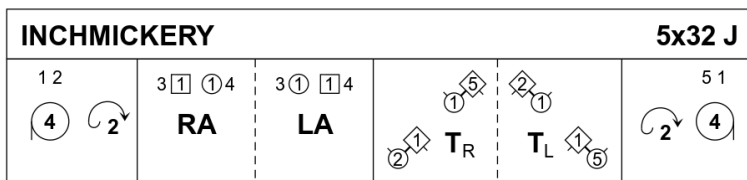

Roy Goldring, 2000, 14 Social Dances

5C/5C longwise set.

Flight to Melbourne
32R - 4C/Sq - Shirley Campbell

- Bars**
- 1-8 1M+3L dance Fig of 8 round 2s **while** 1L+3M dance Fig of 8 round 4s
- 9-16 1s in prom hold dance reel of 3 across with 4M+2L (RSh to 4M to start) **while** 3s dance reel of 3 with 2M+4L (RSh to 2M)
- 17- All Set+Link, 1/2 turn partners RH & all chase clockwise 1
24 place. 4 1 2 3
- 25- All circle 8H round & back. 4 1 2 3
32

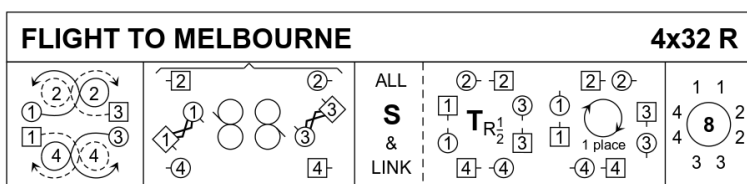

Shirley Campbell, Leicester Silver Collection, RSCDS Book 47.3

4C/4C square set.

Gourdieburn
32S - 3C/3L - Margaret Cowie

- Bars**
- 1-8 1s turn RH & cast 1 place, dance down between 3s & cast back to 2nd places
- 1s pass LSh & dance 1/2 reel of 4 with 1st corners, pass RSh &
- 9-16 dance 1/2 reel of with 2nd corners ending in 2nd place opposite sides
- 17- 1s petronella turn as 3s+2s change places RH on sides into
20 lines across & all set down/up
- 21- 1s petronella turn as 2s+3s cross RH to own sides & all set
24
- 25- 1s dance up between 2s & cast to 2nd place, 1s+3s dance 1/2
32 Diamond Poussette. 2 3 1

No diagram available

Miss Hadden's Reel
32J - 3C/4L - RSCDS

- Bars**
- 1-8 1s+2s+3s circle 6H round & back
- 9-16 1s set & cast (2s step up); 2s+1s+3s all turn RH to end in Allemande hold ready for ...
- 17- 2s+1s+3s dance Allemande
24
- 3s+1s+2s Adv+Ret for 2 steps; 3s cast to 3rd place **while** 1s+2s dance up, 1s casting to 2nd place. 2 1 3 2nd turn bars 29-32: 3s cast to bottom & dance up to 3rd place, original 1s cast to bottom, 2s dance up to place

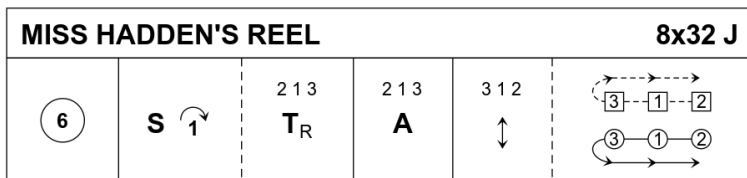

RSCDS Publications Committee, 1967, RSCDS Book 23.5

3C/4C longwise set.

We've Nae Electric
32R - 5C/5L - Gary Coull

Bars

- 1-8 1s+3s cross down RH into double triangle position & set, dance round 1st corner into a line up/down middle facing partner
- 9-16 1s+3s dance RSh reel of 4 in centre **while** 2s+4s+5s dance LSh reels of 3 on sides (4M in & up, 4L in & down to start)
- 17-24 1s & 3s 1/2 turn partner RH, dance RSh round 2nd corner & turn partner RH 1.1/2 times to 2nd/4th place own sides
- 25-32 2s (at top) stand **while** 1s+4s also 3s+5s Set+Link; All turn RH to end 2 4 1 5 3

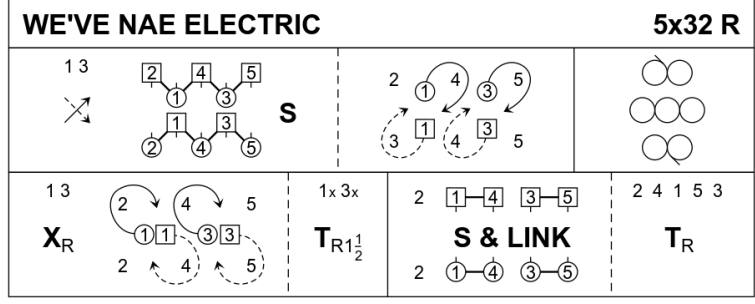

Gary Coull, Jubilee Book 1929-2004

5C/5C longwise set.

The Byron Strathspey
32S - 3C/3L - John Drewry

Bars

- 1-8 All petronella turn into the centre & set to partner, turn 2H 1.1/4 times back to places
- 9-16 1s+2L & 3s+2M dance RH across, 2s pass RSh & dance LH across with other couple
- 17-24 2s in prom hold dance reel of 3 with 1s passing 1L RSh. End with 2s in centre at top, 1s casting to follow 2s & 3s stepping in ready for ...
- 25-32 2s+1s+3s dance Allemande. 3 1 2

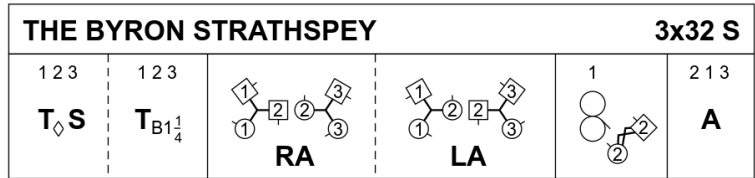

John Drewry, 1975, Deeside Book 2

3C/3C longwise set.

Ian Powrie's Farewell to Auchterarder
128J - 4C/Sq - Bill Hamilton

Bars

- 1-8 All circle 8H round to the left & back (popular variation - 8 hands all the way round to left)
- 9-24 Ladies dance in front of ptr & behind next Man, into RH across, in front of Man opp own ptr & behind next Man, into RH across & back to place
- 25-32 All Promenade clockwise
- 33-40 1s & 3s dance cl'wise behind next couple & Men dance past cpl as Ladies dance in between cpl & both turn R to face cpl, all set & turn RH
- 41-48 All dance parallel reels of 4
- 49-56 1s & 3s dance a full Fig of 8 round the standing 2s/4s
- 57-64 1s & 3s dance LH across, 1s & 3s dance back to places (Men round & Ladies through the standing 2s & 4s)
- 65-96 2s & 4s repeat 33-64
- 97-104 All Promenade anticlockwise
- 105-120 Men dance in front of ptr & behind next Lady, into LH across, dance in front of Lady opp own partner & behind next L into LH across & back to pl
- 121-128 All circle 8H round to the right & back (popular variation - 8 hands all the way round to right)

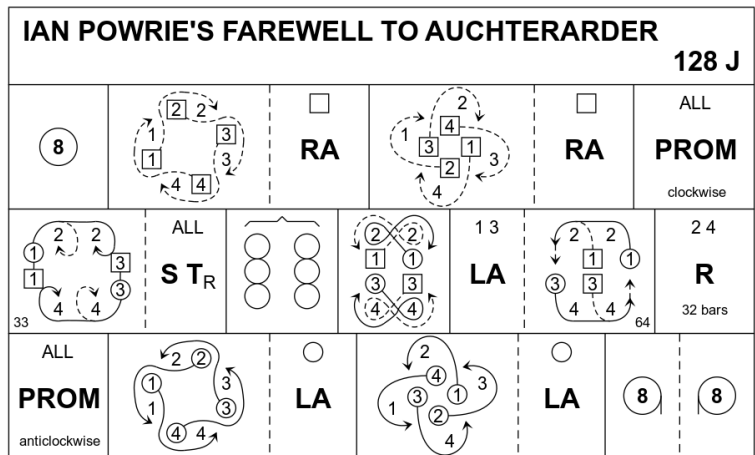

Bill Hamilton, Ian Powrie's Farewell to Auchterarder, Edinburgh 90th, RSCDS 30 Popular Dances V 2 4C/4C square set.

Mairi's Wedding
40R - 3C/4L - James B Cosh

Bars

- 1-8 1s turn RH & cast to 2nd place (2s step up); 1s turn LH to face 1st corners
- 9-16 1s dance 1/2 diagonal reel of 4 with 1st corners, 1s dance 1/2 diagonal reel with 2nd corners
- 17-24 1s dance 1/2 diagonal reel with 3rd corner (pstns), 1/2 diagonal reel with 4th corner (pstns)
- 25-32 1s dance reel of 3 across (Lady with 2s, Man with 3s - LSh to 1st corner)
- 33-40 2s+1s+3s circle 6H round & back

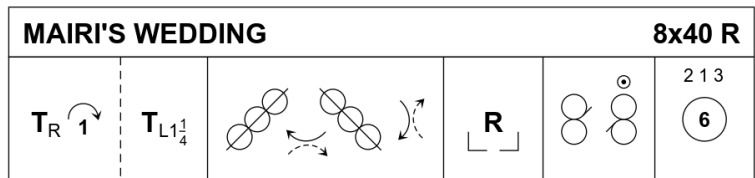

James Cosh, 1959, 22 SCDs, RSCDS Thirty Popular Dances Vol 2

3C/4C longwise set.

Postie's Jig
32J - 4C/4L - Roy Clowes

Bars

- 1-8** 1s & 4s set & cast in 1 place, 1s & 4s dance 1/2 Figs of 8 round new end couples
- 9-12** 1M+4M & 1L+4L cross (men making an arch) & turn corners with free hand to face up/down
- 13-16** 1s+4s dance down/up (couple dancing up make the arch) & turn corners
- 17-24** Repeat bars 9-16 from new positions
- 25-32** 1s+4s dance 1/2 R&L, turn partner RH

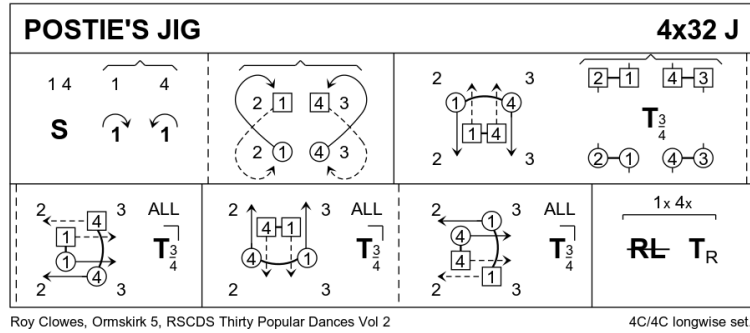

MiniCribs which are compiled by Upton, Deeside Caledonian Society, and his successors. Keith Rose diagrams and ecribs by Eric Ferguson.

These are brief descriptions on the dances. They may contain errors. Check original sources for full instructions